GEMINI SERIES
TELEPHONE
MODEL IQ330

OPERATING INSTRUCTIONS

INTERQUARTZ®

CONTENTS

1. FEATURES	2
2. GENERAL CONTROLS AND INDICATORS	3
MULTIFUNCTIONAL INDICATOR LIGHT	4
RINGER VOLUME SWITCH	4
ALPHA-NUMERIC KEYPAD	4
CRADLE SWITCH	4
RECALL KEY	4
BASIC OPERATION	5
REDIAL / PAUSE KEY	5
HEARING-AID COMPATIBILITY	5
3. ADVANCED NETWORK OPERATION	6
PAUSE FUNCTION WHEN DIALING	6
HOLDING AND TRANSFERRING CALLS	6
4. INSTALLATION	7
UNPACKING	7
GENERAL SETTING-UP	7
LOCATION	7
WALL MOUNTING	7
LINE CONNECTION	10
TECHNICAL ADJUSTMENTS - FOR CORRECT OPERATION	10
MESSAGE WAITING LIGHT COMPATIBILITY	10
DATA PORT SWITCH	11
SHARED MODE	11
SPLIT MODE	11
5. GENERAL CARE AND MAINTENANCE	12
CLEANING	12
FAILURE TO OPERATE AND SERVICE DIFFICULTIES	12
6. THUNDERSTORMS	13
7. WARRANTY - 3 YEARS	13
8. SERVICE CENTRES	14

1. FEATURES

- *Tone dialing*
- *Super bright LED ringer lamp allows visual ringing indication*
- *Built-in switchable Message Waiting option to suit any neon (80 VDC) type message waiting system AND Ericsson BP250 Message Waiting (other system types optional)*
- *User selectable ringer volume*
- *Redial and Pause functions*
- *Recall facility with flash timing 100 mS*
- *Switchable data port allows connection to a second line to enable simultaneous voice and data*
- *Compatible with direct lines, intelligent networks, PABXs and any analog line*
- *Call Waiting compatible*
- *Telstra Customnet compatible*
- *Line powered, unaffected by mains power interruption*
- *REN (Ringer Equivalence Number) = 0.68 allows multiple parallel devices on the same line without loading incoming ring*
- *Alpha-numeric keypad allows full access to services that require the entering of numerals and letters*
- *Fully modular connection provides maximum ease of installation on desk or wall*
- *3 years warranty*
- *Hearing Aid compatibility*

2. GENERAL CONTROLS AND INDICATORS

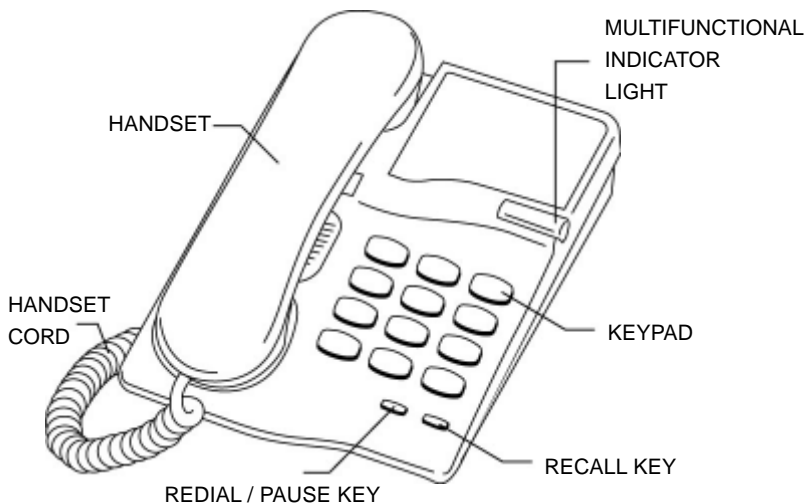

FIGURE 1 : TOP VIEW

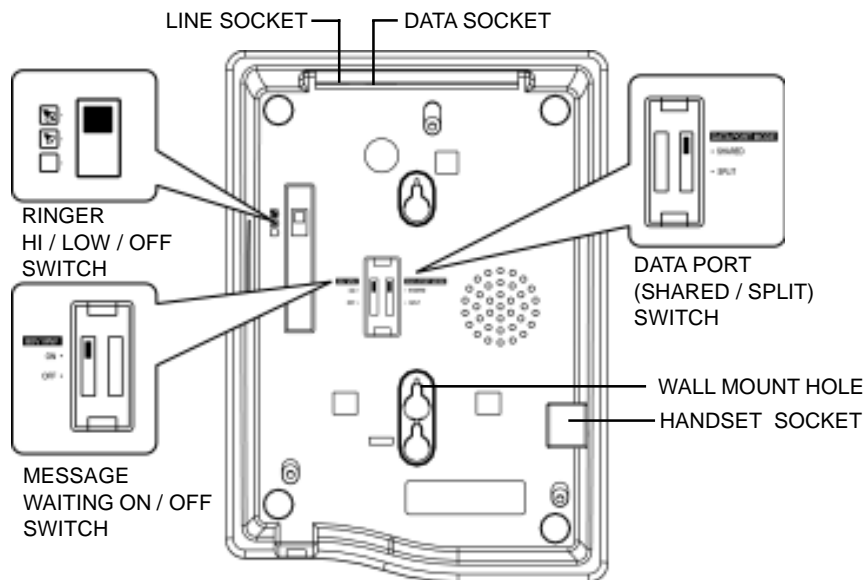

FIGURE 1 : BOTTOM VIEW

(NOTES: EARLY VERSION WILL NOT HAVE THE DATA PORT SWITCH FITTED, AND IS PERMANENTLY WIRED IN SHARED MODE.)

MULTIFUNCTIONAL INDICATOR LIGHT

There are two different functions:

Ring Indicator: Flashes when the telephone rings with an incoming call

Message-Waiting Indicator: Illuminates when a message is waiting in your voicemail system (depends on system compatibility). The built-in Message Waiting option suits any neon (80 VDC) type message waiting system and also the telephone has Ericsson BP250 Message Waiting built-in (other system types are optional extras).

RINGER VOLUME SWITCH

The three available positions allow selection of OFF (no sound), LOW volume, and HIGH volume of the telephone's ringing sound during an incoming call.

ALPHA-NUMERIC KEYPAD

The standard numeric digits are available for normal dialing. The alphabetic characters are provided to allow full access to services that require the entering of numerals and letters.

CRADLE SWITCH

Located in the handset cradle, this plastic lever is depressed by the handset (when placed in the cradle) to cut off the line. Note: Depressing this cradle lever too briefly when intending to terminate a call may result in an accidental "hookflash" that will inadvertently place the call on hold. This is known as "phantom calls" because the held call will probably ring again at your extension within a few minutes (the other party will have hung up, so it will seem as if you were called by a phantom, hence the name "phantom calls"). If you experience this problem, when terminating your call please depress the cradle lever a little longer before making/receiving your next call (i.e. it is not a system or telephone fault).

RECALL KEY

For use with host telephone systems to invoke special network facilities such as call-hold or call-transfer available in your system.

BASIC OPERATION

The telephone can be used as a normal telephone; lift the HANDSET to answer an incoming call, or lift the HANDSET and dial on the KEYPAD to commence an outgoing call. Please refer to the appropriate sections to learn more about advanced operating instructions.

REDIAL / PAUSE KEY

Redial Function

Press to redial the last number previously dialed, which may be up to 32 digits long. Dialing more than 32 digits during one call will cause erasure of the entire number from the redial memory.

EXAMPLE : TO REDIAL LAST NUMBER

1. Lift HANDSET,
2. Press REDIAL .

Pause Function

The Pause command may be needed if your phone is connected to any network where a pause is required (e.g. between internal and external dial tones).

For manual dialing:

1. Lift HANDSET.
2. Dial any digits required before the pause
3. Press PAUSE
4. Dial the remaining digits.

DATA PORT AND SWITCH

The data port provides access to the telephone line for computers (with a modem), answering machines and cordless phones. The Data Port switch (see figure 4 & 5) determines whether the Data Port shares the line with the telephone (position shared) or has its own line (position split).

(Note: EARLY VERSION WILL NOT HAVE THE DATA PORT SWITCH FITTED, AND PERMANENTLY WIRED IN SHARED MODE.)

HEARING-AID COMPATIBILITY

Provided as a standard feature for users with a "T switch" type hearing-aid.

3. ADVANCED NETWORK OPERATION

Where this telephone is used on an intelligent network such as Easycall, Customnet, Centel, a PABX or other network the following information may be useful.

PAUSE FUNCTION WHEN DIALING

Depending on your telephone system, this may or may not be required. If in doubt, check with your system supplier or Interquartz dealer, as failure to observe your system's requirements may lead to difficulty in making outgoing external calls. If you have determined that a pause is required by your host system, please refer to the PAUSE Function section to ensure correct usage of the PAUSE button.

HOLDING AND TRANSFERRING CALLS

The method used for these functions is dependent on your system type, so you will need to check your system's Extension User Guide. The RECALL KEY is typically used to transfer calls.

4. INSTALLATION

UNPACKING

The carton contains the following :

- Telephone body and handset
- Coiled cord and line cord
- This User Manual.

GENERAL SETTING-UP

1. Fit the COILED CORD to the appropriate sockets in the HANDSET and the telephone base
2. Fit the LINE CORD to the rear socket and to your telephone network outlet
3. Set the Ringer Volume
4. See following sections to complete the installation.

LOCATION

The telephone should be placed on a desk, table or shelf where it is not likely to be pushed off. If the unit is to be wall mounted, it should be seated securely on the WALL MOUNTING BRACKET. Avoid excessive heat, damp, dust, direct sunlight, vibration, and other appliances or devices that may transmit or emit electrical or electromagnetic radio frequency noise or signals (e.g. computers, welders, pagers).

WALL MOUNTING

1. Fit the WALL MOUNT BRACKET (optional, not supplied) to the wall and attach the WALL MOUNT BRACKET to the underside of telephone (see Figure 2)
2. To enable the HANDSET to be supported in the cradle, follow the procedure shown in (Figure 2) to reverse the HANDSET RETAINER.
3. NOTE: The WALL MOUNT BRACKET and MODULAR WALL JACK illustrated in (Figure 2) are available from your authorised Interquartz dealer and can be ordered as "Wall Mount Kit No.3".

1. Use your thumb to press the
HANDSET RETAINER

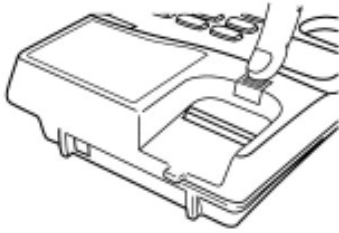

2. Push the HANDSET RETAINER
out of the slot.

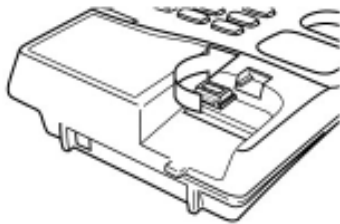
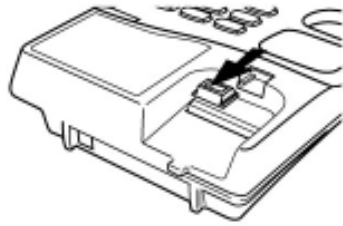

3. Rotate the HANDSET
RETAINER by 180 °

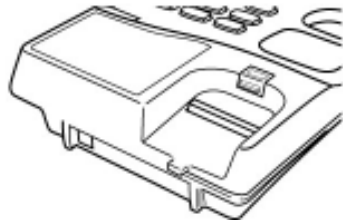

4. Insert the HANDSET RETAINER
back into its slot.

FIGURE 2: WALL MOUNTING

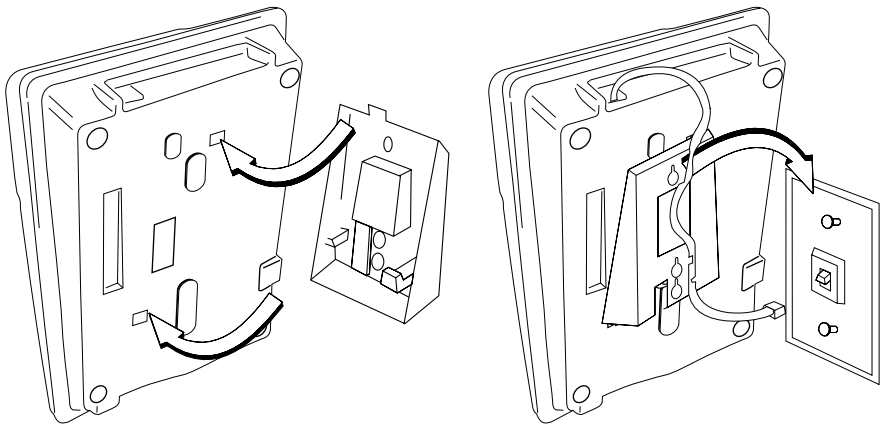
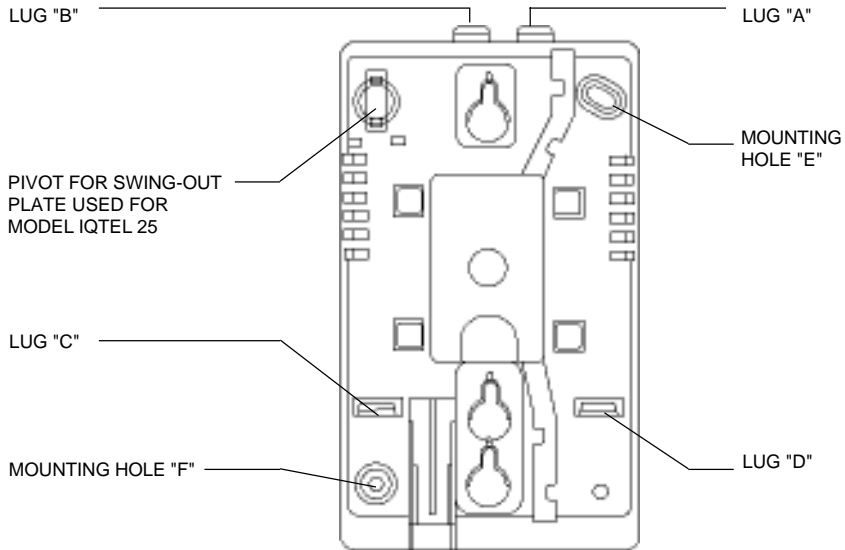

FIGURE 2 : WALL MOUNT BRACKET

WALL-MOUNT BRACKET (OPTIONAL NOT INCLUDED WITH PHONE)



Please note:

1. This wall bracket may be secured onto the wall by using mounting holes "E" and "F"
2. Lugs to break off before wall mounting the phone.

TELEPHONE MODELS		BREAK OFF LUGS
IQ 90 IQ 150 IQ 250 IQ 260 IQ 360 IQ 350 IQ 450 IQ 550 IQ E2 IQ E3	IQTEL 80 IQTEL 300 IQTEL 500 IQTEL E1 IQTEL E2 IQTEL E3 IQTEL ET STUDIO 20 GEMINI IQ33X SERIES	"B" and "D"
IQTEL 25		"A" and "C"
IQ 300 9853 XT 9835 MKII 9836 9837		"A" ONLY

FIGURE 3

LINE CONNECTION

This telephone is supplied with a RJ45 Plug as the wall plug, with the centre pair being reserved for speech and signaling. Other types of plugs and cords are available on request.

TECHNICAL ADJUSTMENTS - FOR CORRECT OPERATION

MESSAGE WAITING LIGHT COMPATIBILITY

Located in the Multifunctional Indicator Light, the Message Waiting Light can be optionally configured at time of order to be compatible with most host telephone systems on the Australian market. The standard factory fitted message waiting light is a neon style circuit suitable for minimum 80V DC signaling and is compatible with NEC, FUJITSU, ALCATEL, later HYBREX and NORTEL PABX systems. The Message Waiting Light switch is located on the telephone's underside which enables or disables the light, and is factory set in the ON position.

If this telephone is configured to "message waiting" mode please note that it is only for PABX systems (contact your vendor for clarification). If so, it may not be connected to any other telephone system or network without the authority of the Australian Telecommunications Authority. For direct line use, please disable the message waiting feature using the switch on the telephone's underside.

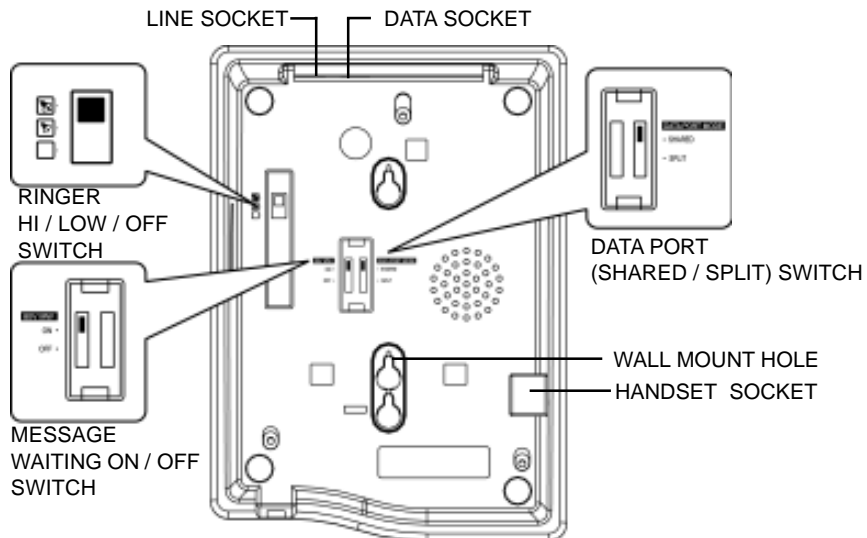

FIGURE 4

(Note: EARLY VERSION WILL NOT HAVE THE DATA PORT SWITCH FITTED, AND PERMANENTLY WIRED IN SHARED MODE.)

DATA PORT SWITCH

The data port switch (SHARED or SPLIT) determines whether the data port shares the line with telephone (position “shared”) or has its own line (position “split”)

(NOTE: EARLY VERSION WILL NOT HAVE THE DATA PORT SWITCH FITTED, AND ARE PERMANENTLY WIRED IN SHARED MODE.)

SHARED MODE

This mode uses one analog telephone line and provides the user with access to a Data Port, but in this mode the telephone’s voice capability is disabled while the Data Port is in use. The line cord as supplied is terminated with RJ45 at the wall end. For Shared mode the telephone line should be terminated on pins 4 and 5 of the matching RJ45 compatible wall socket. Different plug or cord types can be provided to suit your wall socket - please contact Interquartz or your dealer. The telephone will be factory set in Shared mode.

SPLIT MODE

To enable the user to simultaneously access both the Data Port and the telephone (i.e. “Split” mode) a second analog line must be allocated to the Data Port, and the Data Port Mode Switch must be set to Split mode. The line cord as supplied is terminated with RJ45 at the wall end, with the voice pair in the middle (pins 4 and 5) and the dedicated data line pair (for “Split” mode) on pins 3 and 6. For Split mode the telephone line pair should be terminated on pins 4 and 5 of the matching RJ45 compatible wall socket. The new dedicated analog DATA line pair must be terminated on pins 3 and 6 of the RJ45 compatible wall socket where the voice pair is also located. Different plug or cord types can be provided to suit your wall socket - please contact Interquartz or your dealer. The telephone will be factory set in Shared mode. The Data Port Mode Switch is found on the underside of the telephone. (See figure 5)

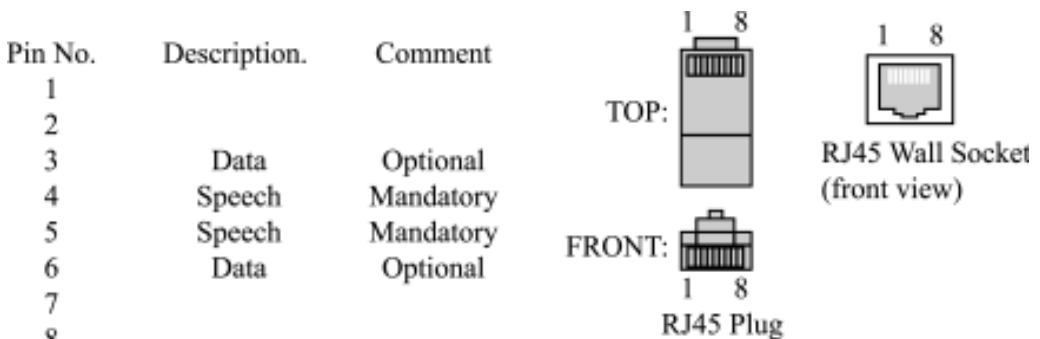

FIGURE 5 PIN ASSIGNMENT OF RJ45 LINE CORD PLUG

5. GENERAL CARE AND MAINTENANCE

This telephone is a precision electronic instrument. While in use and storage, care should be taken to avoid rough handling, extreme temperature, and damp or dirty environments.

CLEANING

NEVER use aerosol sprays or other chemical agents or substances that leaves a residue (furniture polish for example).

Use a mild detergent and a damp, clean cloth when cleaning. Do not allow moisture to enter the telephone's interior - damage may result!

FAILURE TO OPERATE AND SERVICE DIFFICULTIES

If telephone service problems occur at any time, it is recommended that the installation procedure described in this manual be re-checked.

If a fault occurs, try to determine if the fault is with the telephone, or with the network or system to which the telephone is connected:

Disconnect the "suspect" telephone, and test the line with a substitute telephone. If the telephone service then operates satisfactorily, the fault is in the "suspect" telephone.

Test the "suspect" telephone on a known good line. If the fault still occurs, the fault is in the "suspect" telephone.

Consult your Interquartz dealer for further advice if necessary.

6. THUNDERSTORMS

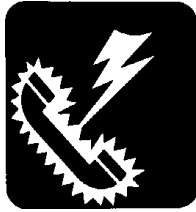

The telephone, in common with household electrical appliances, can be a source of electric and acoustic shock during thunderstorms. The possibility of a telephone user experiencing a shock is minimal. Nevertheless, customers should be aware of some simple precautions to follow during thunderstorms:

Use your telephone only for calls of the utmost urgency. Keep these calls brief.

Whilst using your telephone keep clear of electrical appliances and metal fixtures such as: stoves, air conditioners, refrigerators, window frames and sinks.

7. WARRANTY - 3 YEARS

Interquartz (A'Asia) Pty Ltd warrants the original purchaser against failure, under normal usage and in the environment and network for which it was designed, resulting from defective material and workmanship at time of manufacture for a period of THREE YEARS from the date of purchase. Proof of purchase and date of purchase are required for determining validity of this warranty. This warranty does not cover defects or damage due to normal wear and tear, negligence, accidents, exposure to radiation, misuse, obsolescence, incompatibility, improper maintenance, lightning strikes or unauthorised repairs or modifications and excludes freight or postage costs to/from your local authorised service centre unless otherwise arranged. Consequential loss not included. Notification of any defect must be made within the warranty period before a warranty repair can be effected. This guarantee is in addition to all other Warranties or Guarantees expressed or implied by the Trade Practices Act or other Commonwealth or State laws and all other obligations and liabilities on the part of Interquartz (A'Asia) Pty. Ltd.

8. SERVICE CENTRES

Please call Modern Communication Systems 5522 2222 to arrange service or repair of your telephone.

Manufactured by
International Quartz Limited

A Subsidiary of Chiaphua Industries Ltd.

©Copyright INTERNATIONAL QUARTZ LTD. 2002

3C933001-03B